

6	5	4	3	2	1
Spec.	kg				Confirmed
Model	Weight				
HJ-21	14.3				

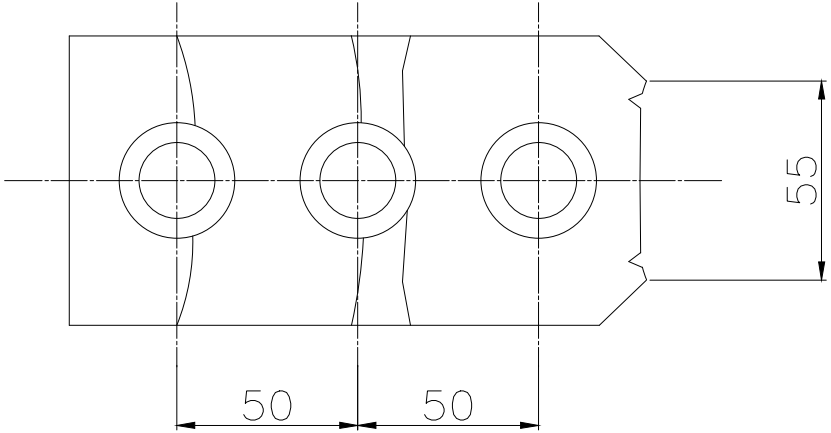
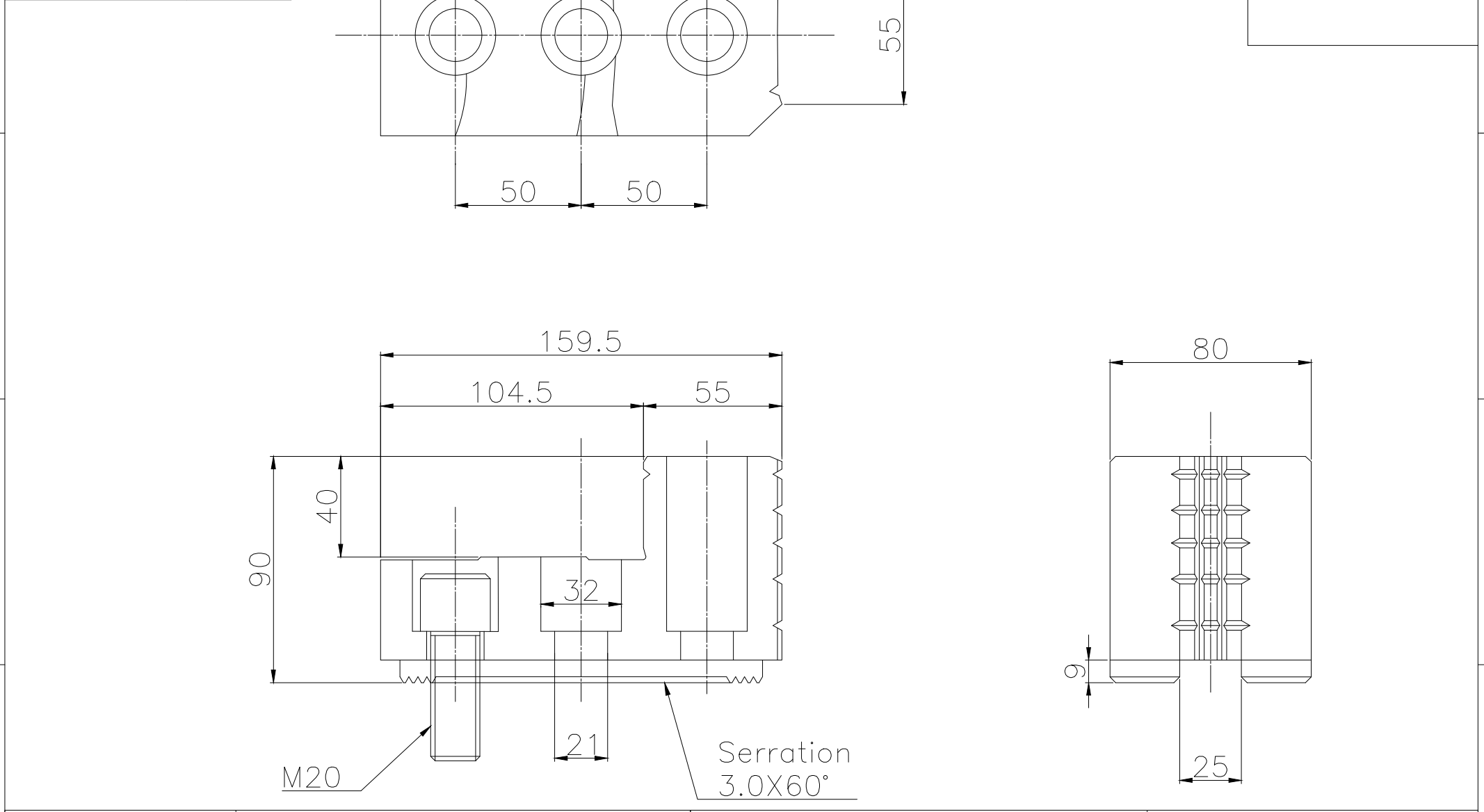
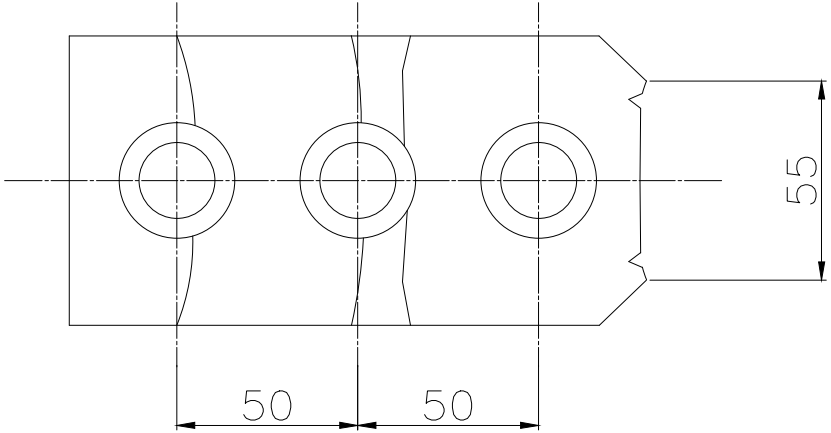

LEADER CHUCK INTERNATIONAL
+44 (0) 1827 700000
+353 (0)1 254 2555
INFORMATION@LEADERCHUCK.COM
LEADERCHUCK.COM

TITLE: STANDARD HARDEN
JAW FOR 3MF CHUCK

DRAWING NO.: A4\AG-HJ-21



6	5	4	3	2	1
---	---	---	---	---	---