

6 5 4 3 2 1

Spec.	kg
Model	Weight
HJ-15H	9.6

Confirmed

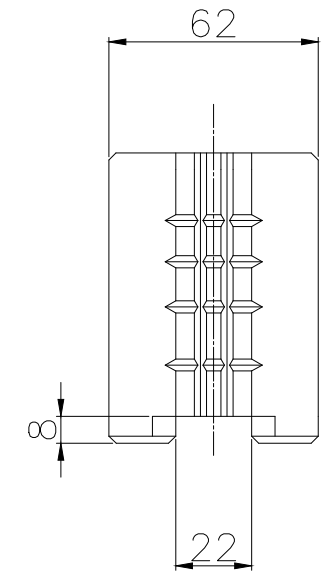
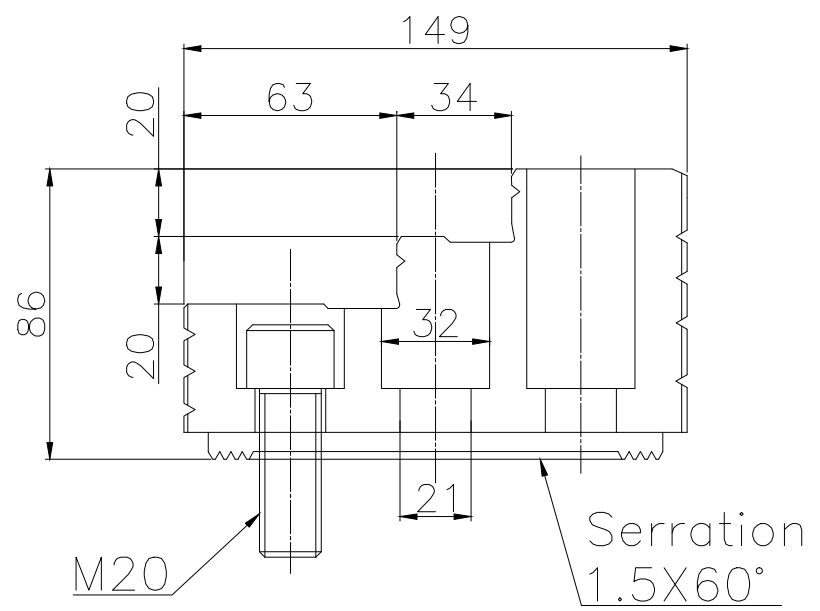
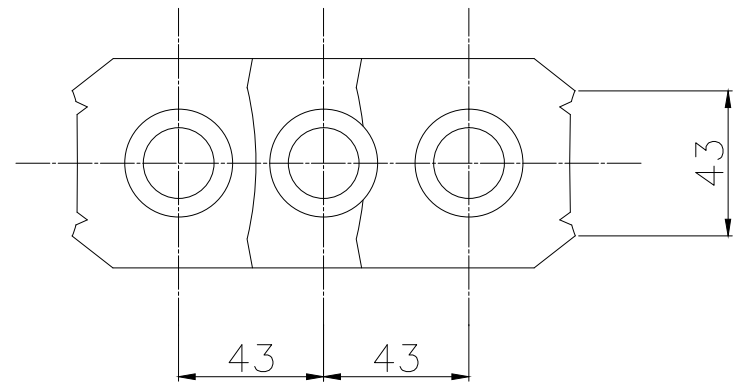

LEADER CHUCK INTERNATIONAL
 +44 (0) 1827 700000
 +353 (0)1 254 2555
 INFORMATION@LEADERCHUCK.COM
 LEADERCHUCK.COM

TITLE: STANDARD HARDEN
 JAW FOR 3MF CHUCK

DRAWING NO.: A4\AG-HJ-15H



6 5 4 3 2 1