

Spec.	7		6		5		4		3		2		1	
	mm	mm	Chuck Dia. mm		kgf	kgf	r.p.m.	l	kg	Confirmed				
Model	Plunger Stroke	Jaw Stroke (Dia.)	Max.	min.	Max D.B. pull	Max clamping force	Max speed	kg m <sup>2</sup>	Weight					
F 3D-06	10	7.2	165	22	1530	2250	3500	0.051	15					

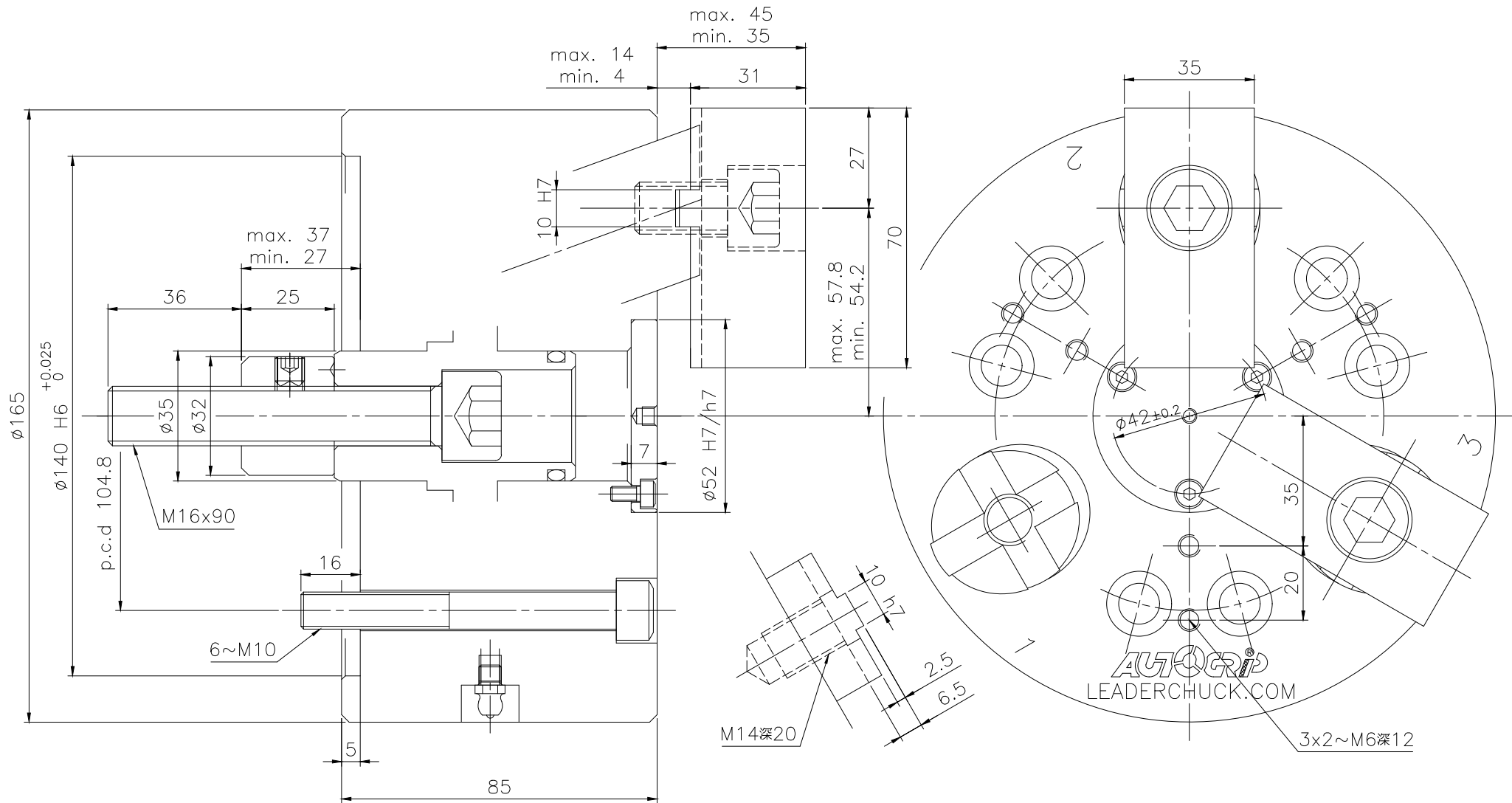

LEADER CHUCK INTERNATIONAL  
+44 (0) 1827 700000  
+353 (0)1 254 2555  
INFORMATION@LEADERCHUCK.COM  
LEADERCHUCK.COM

TITLE:  
Zhongshi back pull three-jaw chuck

DRAWING NO.:  
A3\AG-3D-06

